

**POWERFLOOD 9 - Separate power supply box - 39W - 5370 lm**  
829-0520 POWERFLOOD 9 1,4A 3000K 2x5° Ø257mm 38W IP66

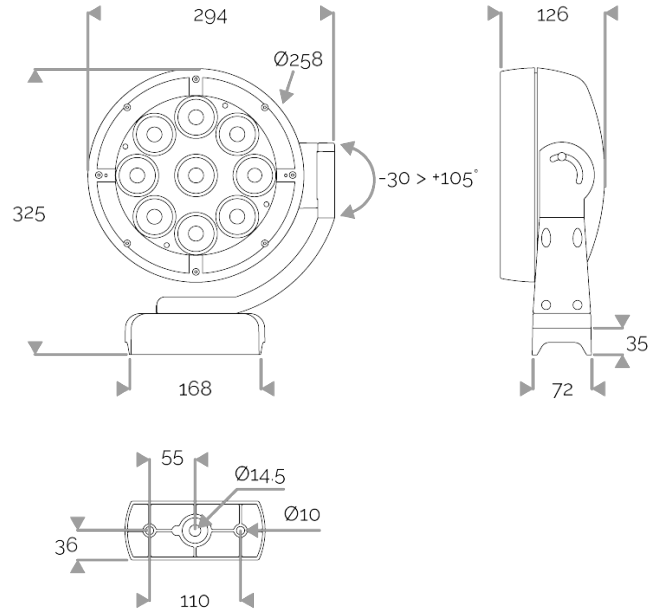

**APPLICATION**

Monochrome LED projector for outdoor lighting.  
For use in urban lighting, squares, car parks, architectural accentuation etc...

**LIGHTING FEATURES**

CRI70. 9 LEDs monochrome.

**ELECTRICAL FEATURES**

Luminaires are wired in parallel using a separate 24V DC power supply + 10 kV/5 kA surge protector for the pole. Luminaire comes in a fixed or dimmable version. Control and cable length to be specified when ordering.

**CABLE USED**

Fixed & controlled version: HO5RN-F 2x1mm<sup>2</sup> cable: blue- et brown+.

**MECHANICAL FEATURES**

IP66, IK10. Cast aluminium, sandblasted RAL paint.  
Extra-white tempered glass. Silicone gasket. Captive stainless steel fasteners with Delta Seal®.  
Glare shield in raw aluminium, and RAL paint to be defined. Wind pressure = 0,09m<sup>2</sup>. Weight: 8 kg.

**WARRANTY**

5-year warranty: on LED module and driver (see the FLUX conditions).



**Lifetime: 60 000 hours L80 B10**

**LUMEN DATA**

Lumen nominal total warm white 3000K (lm)	4653
lm/W LED warm white 3000K	120,5
Qty LED	9
Ta max.	30°C
Tj (at 25°C)	85°C

**POWER**

Product Led Power (W)	38,6
-----------------------	------

