

POWERFLOOD 9 - Separate power supply box - 39W - 5370 lm
829-3220 POWERFLOOD 9 1,4A 2700K 2x3,7° Ø257mm 38W IP66

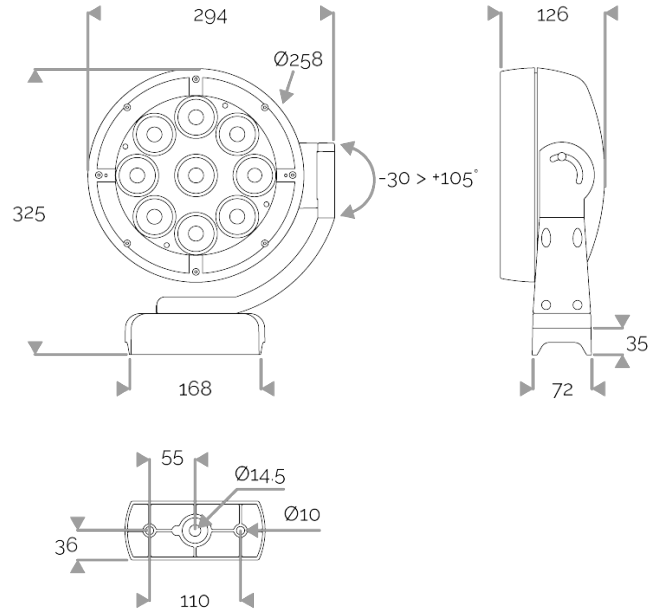

APPLICATION

Monochrome LED projector for outdoor lighting.
For use in urban lighting, squares, car parks, architectural accentuation etc...

LIGHTING FEATURES

CRI70. 9 LEDs monochrome.

ELECTRICAL FEATURES

Luminaires are wired in parallel using a separate 24V DC power supply + 10 kV/5 kA surge protector for the pole. Luminaire comes in a fixed or dimmable version. Control and cable length to be specified when ordering.

CABLE USED

Fixed & controlled version: HO5RN-F 2x1mm² cable: blue- et brown+.

MECHANICAL FEATURES

IP66, IK10. Cast aluminium, sandblasted RAL paint.
Extra-white tempered glass. Silicone gasket. Captive stainless steel fasteners with Delta Seal®.
Glare shield in raw aluminium, and RAL paint to be defined. Wind pressure = 0,09m². Weight: 8 kg.

WARRANTY

5-year warranty: on LED module and driver (see the FLUX conditions).



Lifetime: 60 000 hours L80 B10

LUMEN DATA

Lumen nominal total warm white 2700K (lm)	4419
lm/W LED warm white 2700K	114,5
Qty LED	9
Ta max.	30°C
Tj (at 25°C)	85°C

POWER

Product Led Power (W)	38,6
-----------------------	------

