

**XTO SQUARE - Pole-mounted - 4941 to 9882 lm**  
831-0315 XTO Square Top 32 LED 64W 3000K lantern IP66 Class I

Spigot: Ø76 H75mm

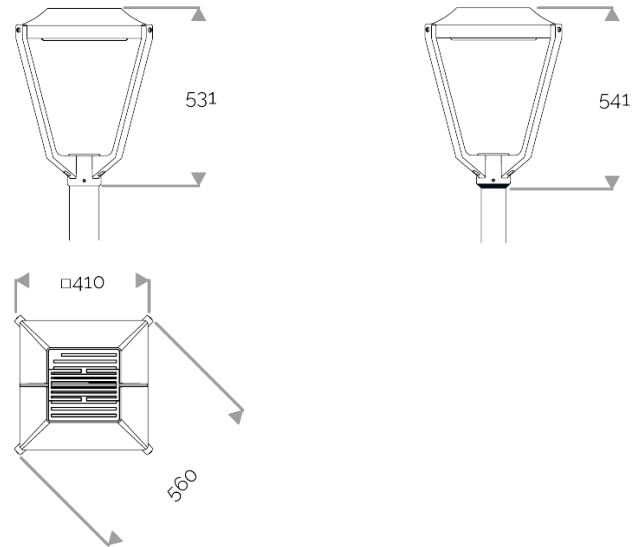

**APPLICATION**

LED street luminaire, 4 supports, post-top mounting. Urban lighting : Roads, streets, squares, car parks. ULR = 0%.

**LIGHTING FEATURES**

CRI70. Single circuit or combined circuit. The direction of the LED light output is to be specified when ordering (forward throw or back throw). Cluster optics to be determined by application:  
16 LED optics cluster – STREET (831-9030). Medium width road lighting. Spacing up to 5.5 times the height of the light source, lighting to the front up to 1.2 times the height.  
16 LED optics cluster – ASYMMETRIC FORWARD THROW (831-9035). Asymmetric lighting for wide roads. Spacing up to 3.5 times the height of the light source, lighting to the front up to 2 times the height.  
16 LED optics cluster – PARK (831-9040). symmetrical lighting, for squares, car parks and park areas. Spacing up to 5.5 times the height of the light source.  
8 LED optics cluster – WALK (831-9045). Spacing up to 4.5 times the height of the light source, lighting to the front up to 1.2 times the height.

**ELECTRICAL FEATURES**

230V mains connection. Integrated driver & 700mA power supply. Built-in 10?kV lightning and surge protection. Cable is not visible. Cable length to be specified in meters when ordering. Control to be specified when ordering (integrated DALI driver, CLO (constant light output), AstroDIM, MainsDIM, StepDIM). Maximum ambient temperature: 30°C.

**MECHANICAL FEATURES**

IP66, IK08. Integrated heat sink. Die-cast aluminium alloy, anti-corrosion treatment prior to polyester powder coating. Hinges allow for the luminaire to be easy opened. Captive stainless steel torx fasteners with a Delta Seal® treatment to reduce galvanic corrosion. RAL colour to be specified when ordering. Wind pressure = 0.036m². Weight: 14,5 kg.

**STANDARDS**

Luminaire compliant with European standard EN60598.

**MAINTENANCE**

Interchangeable LED modules

**WARRANTY**

5-year warranty: on LED module and driver (see the FLUX conditions).



**Lifetime: 100 000 hours L80 B10**

**LUMEN DATA**

Lumen nominal total warm white 3000K (lm)	9384
lm/W LED warm white 3000K	148
lm/W product warm white 3000K	129
Qty LED	32
Ta max.	30°C
Tj (at 25°C)	85°C

**INRUSH CURRENT**

Inrush Current (A)	53
Inrush Current Time (µs)	200

**POWER**

Product Led Power (W)	63,3
Product Power (W)	72,9

