

**EVO - Adjustable pole / bracket Ø76-60 - 2000 to 10000 lm**

841-0105-ZH EVO LED Lantern 4000K 3000lm 17W IP66 CLI Zhaga connect up

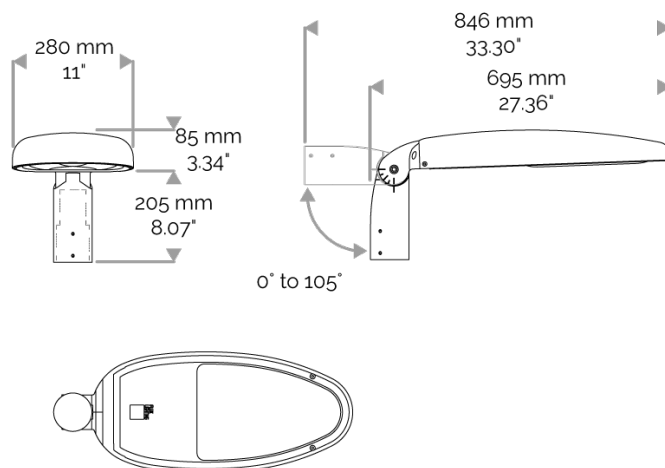

Spigot: Ø76 H80mm / Ø60 H160mm



## EVO - Adjustable pole / bracket Ø76-60 - 2000 to 10000 lm 841-0105-ZH EVO LED Lantern 4000K 3000lm 17W IP66 CLI Zhaga connect up

### APPLICATION

Street luminaire with the COB LED "EASY LIGHT" system. Roads & urban lighting. ULR = 0%.

### LIGHTING FEATURES

CRI80 (CRI65 at 2200K). Ultra-clear UV-resistant silicone lens, and no yellowing.

Photometries to be specified when ordering:

841-9030: STREET proprietary photometry (Spacing up to 5.5 times the height of the light source / lighting to the front up to 1.6 times the height of the light source).

841-9040: ASYMMETRIC FORWARD THROW photometry (Spacing up to 2.5 times the height of the light source / lighting to the front up to 3 times the height of the light source).

### ELECTRICAL FEATURES

230V AC (except for the USA) mains connection. Zhaga LED module. Integrated Zhaga DALIdriver. Zhaga Book 18 connector in option. Built-in 10 kV lightning and surge protection. Cable is not visible. Cable length to be specified in meters when ordering.

Control to be specified when ordering (CLO (constant light output), AstroDIM, MainsDIM, StepDIM). Maximum ambient temperature: 30°C. For the USA please consult us.

### CABLES USED

For class I (AstroDIM, StepDIM, MainsDIM): HO7RN-F 5G1,5mm<sup>2</sup> cable (blue, brown, green/yellow, grey, black).

For class I (StepDIM): HO7RN-F 4G1,5mm<sup>2</sup> cable (grey, brown, green/yellow, black).

For class II (AstroDIM, StepDIM, MainsDIM): 4x1,5mm<sup>2</sup> cable (blue, brown, grey, black).

### MECHANICAL FEATURES

IP66, IK08. Integrated heat sink. Die-cast aluminium luminaire, anti-corrosion treatment prior to polyester powder coating. Easy opening system using hinges. Captive stainless steel fasteners with Delta Seal® galvanic tamperproof treatment. RAL colour to be specified when ordering. Wind pressure = 0,10m<sup>2</sup>. Weight: 7,6 kg.

### STANDARDS

Luminaire compliant with European standard EN60598.

### MAINTENANCE

Interchangeable LED COB module at various manufacturers (LED not owner system).

### WARRANTY

5-year warranty: on LED module and driver (see the FLUX conditions).



**Lifetime: 100 000 hours L80 B10**

### LUMEN DATA

Lumen nominal total neutral white 4000K (lm)	3000
lm/W LED neutral white 4000K	176
lm/W product neutral white 4000K	140
Qty LED	1
Ta max.	30°C
Tj (at 25°C)	85°C

### INRUSH CURRENT

Inrush Current (A)	26
Inrush Current Time (µs)	180

### POWER

Product Led Power (W)	17
Product Power (W)	21,5