

X-LINE QUATTRO - Custom colours

823-0175 X-LINE QUATTRO 5 230V DMX WHITE MIX 2x17° L360mm 29W IP66

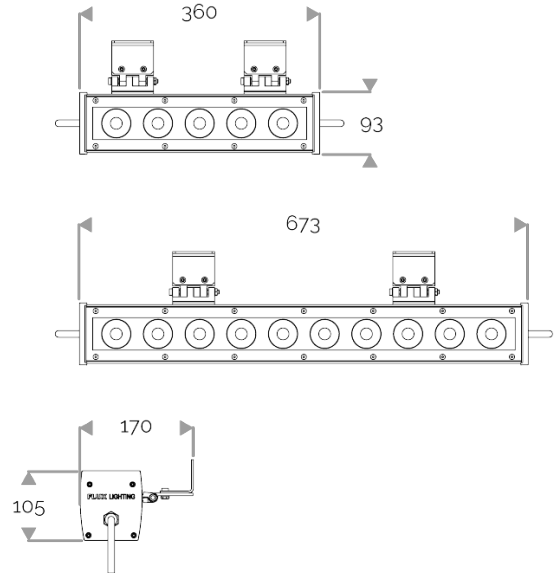

X-LINE QUATTRO - Custom colours

823-0175 X-LINE QUATTRO 5 230V DMX WHITE MIX 2x17° L360mm 29W IP66

APPLICATION

High-power LED luminaire for outdoor lighting available in custom colours. DO NOT RECESS.
Accentuation lighting for architectural facades, shop fronts, sculptures, columns etc...

LIGHTING FEATURES

CRI70. 230V luminaire for outdoor lighting with 20 or 40 LED: : RGBW or customised choice of 2 to 4 colours.

ELECTRICAL FEATURES

CONNECT SYSTEM for reliable and fast installation. Integrated DMX power supply. Built-in 10 kV/5 kA surge protection.

MECHANICAL FEATURES

IP66, IK06. Anodized aluminium profile. Clear PMMA. Silicone gasket. Delta Seal® treated stainless steel fasteners.

Weights: 360mm : 3,8 kg. 673mm : 7 kg.

WARRANTY

5-year warranty: on LED module and driver (see the FLUX conditions).



Lifetime: 60 000 hours L80 B10

LUMEN DATA

Lumen nominal total (lm)	3092
Lumen nominal total warm white 2700K (lm)	722,5
Lumen nominal total warm white 3000K (lm)	722,5
Lumen nominal total neutral white 4000K (lm)	823,5
Lumen nominal total cold white 6500K (lm)	823,5
lm/W LED total	102,4
lm/W LED warm white 2700K	95,7
lm/W LED warm white 3000K	95,7
lm/W LED neutral white 4000K	109,1
lm/W LED cold white 6500K	109,1
Qty LED	5
Ta max.	30°C
Tj (at 25°C)	85°C

INRUSH CURRENT

Inrush Current (A)	60
--------------------	----

POWER

Product Led Power (W)	30,2
Product Power (W)	36,6

