

**POWERFLOOD 3 - Monochrome - 14W - 1896 lm**  
829-1205 POWERFLOOD 3 24V DALI red 2x4° Ø166mm 5W IP66

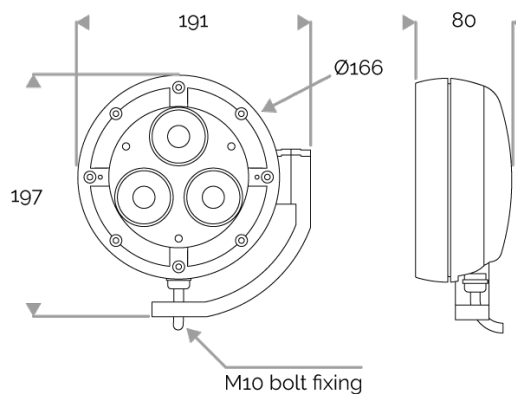

**POWERFLOOD 3 - Monochrome - 14W - 1896 lm**  
829-1205 POWERFLOOD 3 24V DALI red 2x4° Ø166mm 5W IP66



**APPLICATION**

Monochrome LED projector for outdoor lighting.  
For use in urban lighting, squares, car parks, architectural accentuation etc...

**LIGHTING FEATURES**

CRI170. 3 LEDs. Monochrome.

**ELECTRICAL FEATURES**

Luminaires are wired in parallel using a separate 24V DC power supply + 10 kA/5 kA surge protector. Luminaire comes in a fixed or dimmable version. Control and cable length to be specified when ordering.

**CABLES USED**

Fixed version: HO5RN-F 2x1mm<sup>2</sup> cable: blue- & brown+.  
DMX version: numbered black cable, 3x1mm<sup>2</sup>. 1 (V-), 2 (V+), 3 dimming.  
DALI version: 4x0,5mm<sup>2</sup> cable (red, green, blue & black).

**MECHANICAL FEATURES**

IP66, IK08. Cast aluminium, sandblasted RAL paint to be specified when ordering.  
Extra-white tempered glass. Captive stainless steel fasteners with Delta Seal®. Glare shield comes in raw aluminium with the RAL colour to be specified. Wind pressure = 0,04m<sup>2</sup>. Weight: 2,3 kg.

**WARRANTY**

5-year warranty: on LED module and driver (see the FLUX conditions).



**Lifetime: 60 000 hours L80 B10**

**LUMEN DATA**

Lumen nominal total red (lm)	270
lm/W LED red	55,2
Qty LED	3
Ta max.	30°C
Tj (at 25°C)	85°C

**POWER**

Product Led Power (W)	4,9
-----------------------	-----

