

POWERFLOOD 3 - Monochrome - 14W - 1896 lm
829-1265 POWERFLOOD 3 24V DALI amber 2x4° Ø166mm 5W IP66

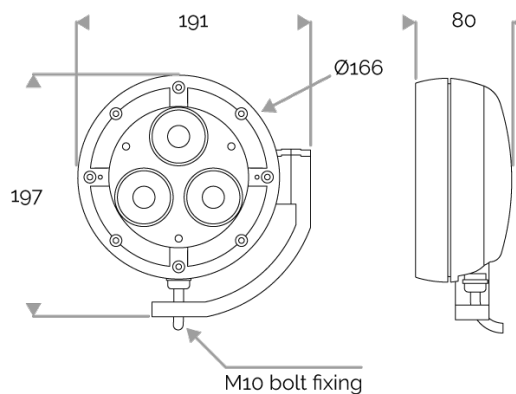

POWERFLOOD 3 - Monochrome - 14W - 1896 lm
829-1265 POWERFLOOD 3 24V DALI amber 2x4° Ø166mm 5W IP66



APPLICATION

Monochrome LED projector for outdoor lighting.
For use in urban lighting, squares, car parks, architectural accentuation etc...

LIGHTING FEATURES

CRI70. 3 LEDs. Monochrome.

ELECTRICAL FEATURES

Luminaires are wired in parallel using a separate 24V DC power supply + 10 kA/5 kA surge protector. Luminaire comes in a fixed or dimmable version. Control and cable length to be specified when ordering.

CABLES USED

Fixed version: HO5RN-F 2x1mm² cable: blue- & brown+.
DMX version: numbered black cable, 3x1mm². 1 (V-), 2 (V+), 3 dimming.
DALI version: 4x0,5mm² cable (red, green, blue & black).

MECHANICAL FEATURES

IP66, IK08. Cast aluminium, sandblasted RAL paint to be specified when ordering.
Extra-white tempered glass. Captive stainless steel fasteners with Delta Seal®. Glare shield comes in raw aluminium with the RAL colour to be specified. Wind pressure = 0,04m². Weight: 2,3 kg.

WARRANTY

5-year warranty: on LED module and driver (see the FLUX conditions).



Lifetime: 60 000 hours L80 B10

LUMEN DATA

Lumen nominal total amber (lm)	146,1
lm/W LED amber	29,9
Qty LED	3
Ta max.	30°C
Tj (at 25°C)	85°C

POWER

Product Led Power (W)	4,9
-----------------------	-----

