

**EVO DECO – Square bracket Ø76-60**  
841-0030 EVO LED lantern 2700K 8000lm 56W IP66 CLI

Spigot: Ø76 H80mm / Ø60 H160mm

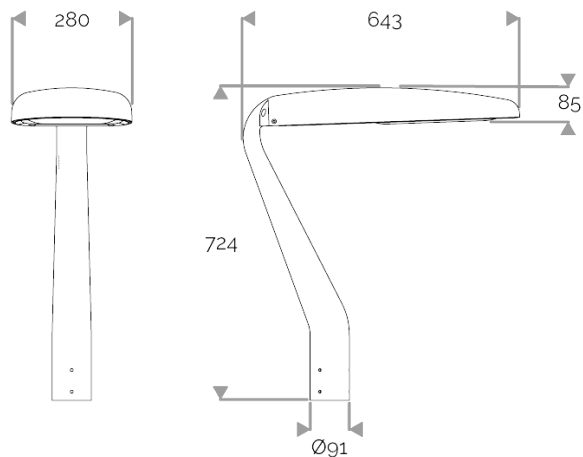

## EVO DECO – Square bracket Ø76-60

### 841-0030 EVO LED lantern 2700K 8000lm 56W IP66 CLI

#### APPLICATION

Street luminaire with the COB LED "EASY LIGHT" system. Roads & urban lighting. ULR = 0%.

#### LIGHTING FEATURES

CRI80 (CRI65 at 2200K). Ultra-clear UV-resistant silicone lens, and no yellowing.

Photometries to be specified when ordering:

841-9030: STREET proprietary photometry (Spacing up to 5.5 times the height of the light source / lighting to the front up to 1.6 times the height of the light source).

841-9040: ASYMMETRIC FORWARD THROW photometry (Spacing up to 2.5 times the height of the light source / lighting to the front up to 3 times the height of the light source).

#### ELECTRICAL FEATURES

230V mains connection. Integrated driver. Built-in 8kV/6kV lightning and surge protection. Cable is not visible. Cable length to be specified in meters when ordering.

Control to be specified when ordering (integrated DALI driver, CLO (constant light output),

AstroDIM, MainsDIM, StepDIM). Maximum ambient temperature: 30°C.

#### MECHANICAL FEATURES

IP66, IK08. Integrated heat sink. Die-cast aluminium luminaire, anti-corrosion treatment prior to polyester powder coating. Easy opening system using hinges. Captive stainless steel fasteners with Delta Seal® galvanic tamperproof treatment. RAL colour to be specified when ordering. Wind pressure = 0.10m². Weight: 7.2 kg.

#### STANDARDS

Luminaire compliant with European standard EN60598.

#### MAINTENANCE

Interchangeable LED COB module at various manufacturers (LED not owner system).

#### WARRANTY

5-year warranty: on LED module and driver (see the FLUX conditions).

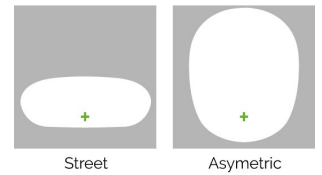

**Lifetime: 100 000 hours L80 B10**

#### LUMEN DATA

Lumen nominal total warm white 2700K (lm)	8000
lm/W LED warm white 2700K	143
lm/W product warm white 2700K	120
Qty LED	1
Ta max.	30°C
Tj (at 25°C)	85°C

#### INRUSH CURRENT

Inrush Current (A)	53
Inrush Current Time (µs)	200

#### POWER

Product Led Power (W)	56
Product Power (W)	66.4