

FICHE TECHNIQUE

302-0245 1CC/surge protection 10kV single power LED 85W 1,4A 1-10V

FLUX
LIGHTING

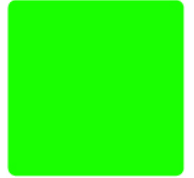

12-12-18

CE RoHS

Photo et schéma produit :

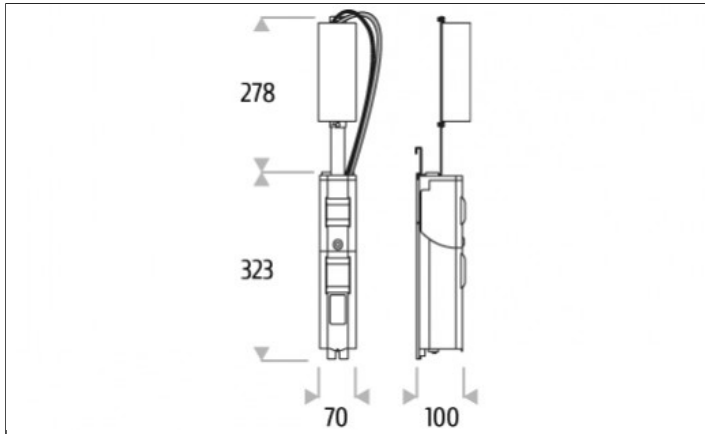

ELECTRICAL CLASS

Class I.

OUTPUT CURRENT

1,4A.

OUTPUT POWER MAX.

85W.

PROTECTIONS

Cutout, protection box IP44.

INNER DIAMETER OF THE POLE

110mm.