

FICHE TECHNIQUE

302-0315 24V DC remote power supply for pole / Surge protection 10kV / Single power supply
24V DC 150W

12-12-18

FLUX
LIGHTING

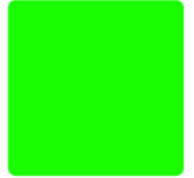

CE RoHS

Photo et schéma produit :

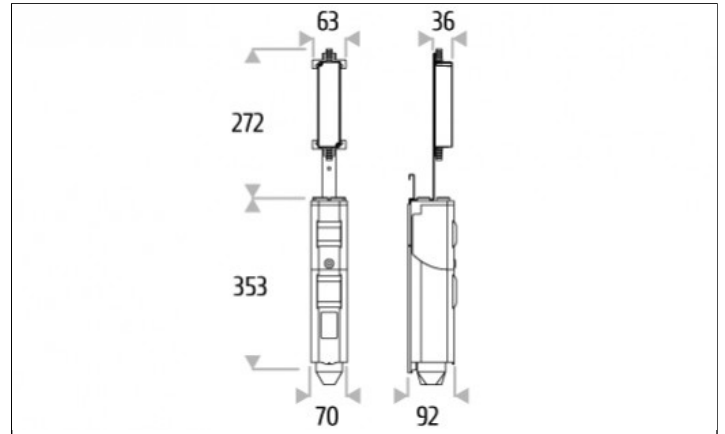

ELECTRICAL CLASS

Class I.

PRIMARY VOLTAGE

100 - 240V AC.

FREQUENCY

50 / 60Hz.

OUTPUT CURRENT MAX.

6,3A.

POWER FACTOR

PF > 0,95 / 230V AC.

INRUSH CURRENT

65A / 230VAC.

SECONDARY VOLTAGE

24V DC.

FICHE TECHNIQUE

302-0315 24V DC remote power supply for pole / Surge protection 10kV / Single power supply
24V DC 150W

FLUX
LIGHTING



PROTECTIONS

Cutout, protection box IP44.

INNER DIAMETER OF THE POLE

110mm.