

# FICHE TECHNIQUE

**302-0320** 24V DC 40W DALI remote power supply for pole, 1CC / Surge protection 10kV

05-02-19

FLUX  
LIGHTING



CE RoHS

Photo et schéma produit :

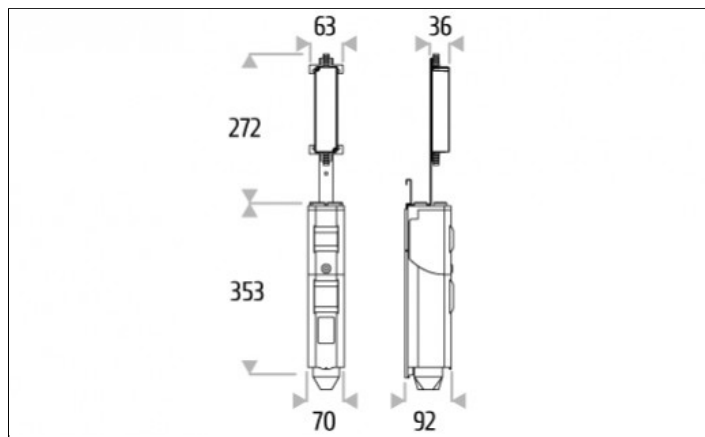

## ELECTRICAL CLASS

Class I.

## PRIMARY VOLTAGE

100 - 240V AC.

## FREQUENCY

50 / 60Hz.

## OUTPUT CURRENT MAX.

1,67A.

## POWER FACTOR

PF > 0,95 / 230V AC.

## INRUSH CURRENT

50A / 230V AC.

## SECONDARY VOLTAGE

24V DC.

# FICHE TECHNIQUE

**302-0320** 24V DC 40W DALI remote power supply for pole, 1CC / Surge protection 10kV

FLUX  
LIGHTING



## PROTECTIONS

---

Cutout, protection box IP44.

## INNER DIAMETER OF THE POLE

---

110mm.